

A 4D-PET block detector based on Silicon Photomultipliers

Sara Marcatili, Nicola Belcari, Maria G. Bisogni, Gianmaria Collazuol, Elena Pedreschi, Franco Spinella, Francesco Corsi, Maurizio Foresta, Cristoforo Marzocca, Gianvito Matarrese, Giancarlo Sportelli, Pedro Guerra, Andres Santos *Senior Member, IEEE*, and Alberto Del Guerra *Senior Member, IEEE*,

Abstract—Next generation PET scanners should fulfill very high requirements in terms of spatial, energy and timing resolution. Modern scanner performances are inherently limited by the use of standard photomultiplier tubes. The use of Silicon Photomultiplier (SiPM) matrices is proposed for the construction of a 4D PET module based on LYSO continuous crystals, which is envisaged to replace the standard PET block detector. The module will provide a submillimetric spatial resolution on the photon hit position, performing at the same time, the Depth Of Interaction (DOI) calculation and the Time Of Flight (TOF) measurement. The use of large area multi-pixel Silicon Photomultiplier (SiPM) detectors requires the development of a multichannel Digital Acquisition system (DAQ) as well as of a dedicated front-end in order not to degrade the intrinsic detector capabilities. At the University of Pisa and INFN Pisa we have developed a flexible and modular DAQ system for the read-out of 2 module in time coincidence for Positron Emission Tomography (PET) applications. Here we describe the acquisition system architecture and its characterization measurements.

I. INTRODUCTION

IN the last years, the Silicon Photomultiplier has been proposed by several research group worldwide as a photodetector for PET (Positron Emission Tomography) applications in replacement of the standard Photomultiplier Tube. In fact, its excellent capabilities are widely acknowledged: the high gain (up to 10^6) and the low noise level does not make it necessary the use of a sophisticated electronics; the small intrinsic time jitter makes it ideal for the construction of TOF (Time Of Flight) PET scanners and its insensitivity to magnetic field opens the way to the assessment of hybrid PET-MRI systems. Moreover,

Manuscript received November 13, 2010. This work was supported by INFN (National Institute of Nuclear Physics), MIUR (Ministero dell'Istruzione, dell'Università e della Ricerca), by European Community in the framework of the FP7 ENVISION project (WP2) and in the framework of the FP7 Hadron Physics 2 project (WP28) and by Altera University Program. CIBER-BBN is an initiative funded by the VINational R&D&I Plan 2008-2011, Iniciativa Ingenio 2010, Consolider Program, CIBER Actions and financed by the Instituto de Salud Carlos III with assistance from the European Regional Development Fund.

S.Marcattili is with University of Pisa and INFN sezione di Pisa, I 56127 Pisa, Italy (telephone: 0039-050-2214940, e-mail: sara.marcattili@pi.infn.it)

N.Belcari, M.G.Bisogni and A. Del Guerra are with University of Pisa and INFN sezione di Pisa, I 56127 Pisa, Italy

G.Collazuol, E.Pedreschi and F. Spinella are with INFN sezione di Pisa, I 56127 Pisa, Italy

F. Corsi, M. Foresta, C.Marzocca and G.Matarrese are with Politecnico di Bari and INFN Sezione di Bari, I 70100 Bari, Italy

P. Guerra is with CIBER-BBN, CEEI-Modulo 3, E 50018 Zaragoza, Spain

A. Santos and G. Sportelli are with Universidad Politecnica de Madrid, E 28040 Madrid, Spain and with CIBER-BBN, Spain

the development of large area SiPM matrices grown on a common substrate and with uniform performances allows for the realization of high granularity imaging surface with negligible dead area.

At University of Pisa we plan to build a $4.8 \times 4.8 \text{ cm}^2$ 4D-PET module constituted by two detection layers. It will provide high spatial resolution (x, y) with DOI (Depth Of Interaction) capabilities (z) in order to reduce the parallax error. The high timing resolution (t) we expect will be used to perform the event TOF (Time Of Flight) so as to increase the SNR (Signal to Noise Ratio).

In the framework of the INFN DASiPM (Development and Application of SiPMs) project we have deeply characterized both single elements SiPMs of different producers and matrices, and we have demonstrated that their characteristics in terms of energy resolution (below 15% FWHM), spatial resolution (0.9 mm FWHM) and time resolution (around 100 ps sigma for a single $3 \times 3 \text{ mm}^2$ SiPM coupled to LSO:Ce,Ca) [1], [2] fulfill our requirements. In addition we have already developed a dedicated front-end in order to manage signals from SiPM matrices without degrading their large dynamic range [3].

Currently an home-made modular acquisition system for the read-out of a first $2.1 \times 2.1 \text{ cm}^2$ prototype of the 4D-PET block detector is under development. This system consists of 9+9 identical DAQ boards housing a custom ASIC front-end chip for the read-out of each detector head. A high performance master FPGA will handle the acquisition of the signals from the front-end boards managing the time coincidence and the TOF algorithm.

II. FOUR YEARS OF R&D ON SILICON PHOTOMULTIPLIERS

SiPM pixels and matrices performances as detector for PET have been deeply investigated by the DASiPM collaboration in the last four years. Photodetectors up to 8×8 pixels with a 1.5 mm pitch produced at FBK-irst (Trento - Italy) [5] have been coupled to LSO scintillator crystals of different sizes and designs in order to study their time, energy and spatial resolution capabilities.

Continuous slabs of LSO of the same size of the detector and 0.5 cm thick have been used to perform spectroscopic measurement with a ^{22}Na source [1], [2]. The typical energy resolution at 511 keV is below 15% FWHM, adequate for PET

applications.

The very low intrinsic time jitter (about 70 ps at single photoelectron level) of the SiPM has been measured [6] using a Ti:sapphire laser with jitter below 100 fs and it has been demonstrated not to significantly affect the module performances when the SiPM is coupled to a scintillator crystal. Measurements made with a $3 \times 3 \text{ mm}^2$ SiPM pixel coupled to a LSO:Ce,Ca crystal of the same area have shown a time jitter resolution slightly above 100 ps sigma for the single device [7] which is comparable to that expected considering LSO decay time properties and detector efficiency.

Extremely encouraging results have been achieved for matrices spatial resolution capabilities when they are coupled to continuous LSO slab painted black on the other faces. A ^{22}Na point source placed very near the detector module has been collimated performing a time coincidence with a far away LSO single pixel of 1 mm^2 surface; in this way a light spot has been obtained, that can be used to scan the module moving the source and the crystal pixel simultaneously. With this setup we were able to reconstruct the spot spatial position with a sub-millimetric resolution (FWHM) [8].

SiPM matrices required the development of a dedicated multi-channel front-end capable to respect their high dynamic range and their excellent timing performances. At Politecnico of Bari, in the framework of the DaSiPM collaboration, a mixed signal ASIC (BASIC chip) for the read-out of SiPM matrices based on a current buffer approach has been developed [3]. In this way the signal can be easily duplicated and split into two lines: a fast one, including a current discriminator, which provides the trigger signal, and a slow one, yielding the analog signal proportional to the energy deposited. The architecture includes also a fast-OR circuit for the ultimate trigger generation (FASTOR) and a standard cell digital module which manages the multiplexing of the channels. The BASIC can provide 3 different gains (1V/pC, 0.5V/pC, 0.33 V/pC). The lower gain guarantees a 70 pC dynamic range, which has been optimized for the read-out of SiPMs coupled to LYSO crystals painted black. An 8 channel version of this chip has already been tested [9] while a 32 channel design is already available and it is currently under test.

III. THE 4D-PET MODULE

In 2006, the availability of first Silicon Photomultiplier matrices grown on a common substrate produced at FBK-irst paved the way to the construction of a high granularity, low noise, high timing resolution imaging device based on silicon photodetectors. At University of Pisa and INFN Pisa we are planning to build a high spatial and time resolution PET module with DOI capabilities. This module, with an overall size of $4.8 \times 4.8 \text{ cm}^2$, could be considered the successor of the standard block detector of the clinical PET scanners.

The module will be based on a single LYSO monolithic scintillator read by two layers of SiPMs placed on the two opposite faces of the crystal. The bottom layer, which is the one where the radiation is entering, will be composed of 12×12 (144) Silicon Photomultiplier pixels with a size of $4 \times 4 \text{ mm}^2$ each, while the top layer will be composed by 4×4 64

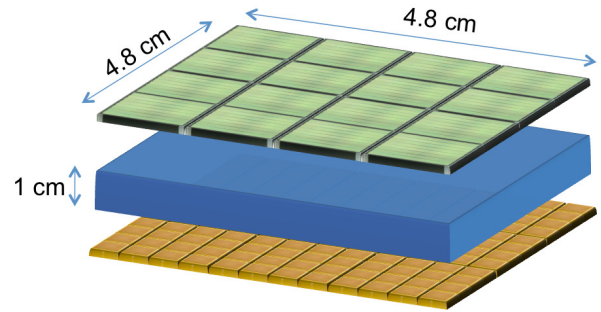

Fig. 1. Conceptual design of the 4D PET prototype. The top layer is composed by 4×4 64 channels SiPM matrices with a 1.5 mm pitch and it will provide the spatial information with a submillimetric resolution. The bottom layer is composed by 12×12 single SiPM pixels of $4 \times 4 \text{ mm}^2$ area and it will provide the timing information. Radiation enters from the bottom layer in order to reduce the time jitter of the whole module.

channel SiPM matrices (See figure 1) on a 1.5 mm pitch. The low spatial granularity detection surface (bottom) will provide improved timing information thanks to the larger photon collection surface of the single detector element. Conversely, the high granularity surface (top), thanks to the small pitch, will allow the reconstruction of the hit position with a high spatial resolution. Data from both sides will be used to reconstruct the depth of interaction (DOI) for each event so as to reduce the parallax error.

In order to avoid internal reflections and improve the spatial resolution capabilities of the module, LYSO crystal will be painted black on the surfaces not facing the detectors.

Currently a proof of principle prototype with reduced size is under construction. It presents the same conceptual design of the previously described module having one quarter of its detection surface ($2.1 \times 2.1 \text{ cm}^2$) and a smaller number of channels; the high granularity surface will be composed by 4 SiPM matrices (256 channels) while the low granularity one will be composed by 36 single SiPM pixels.

A. Read-out system architecture

We have developed an acquisition system for the read-out of two modules of the 4DPET detector. The core of the system is a cross-application acquisition board (called mother board) capable to handle up to 18 DAQ boards in which it is possible to place a dedicated front-end [4].

Each DAQ board will read from 8 up to 32 channels of the detector module depending on the version of the BASIC mounted. The BASIC is housed on a mezzanine board in order to allow an easy replacement of the chip which is possible thanks to the BASIC serial output. In each DAQ board, a single channel, 10 bit, 105 MSPS ADC allows for the conversion of the signals coming from the sample and hold circuit in the BASIC; an FPGA (Cyclone II from Altera) controls the data read-out and sends the energy and timing signals to the mother board when it receives a valid trigger.

A high performance FPGA (Stratix III from Altera) on the mother board will manage the time coincidence algorithm with a time window of about 7 ns FWHM and the TOF signals

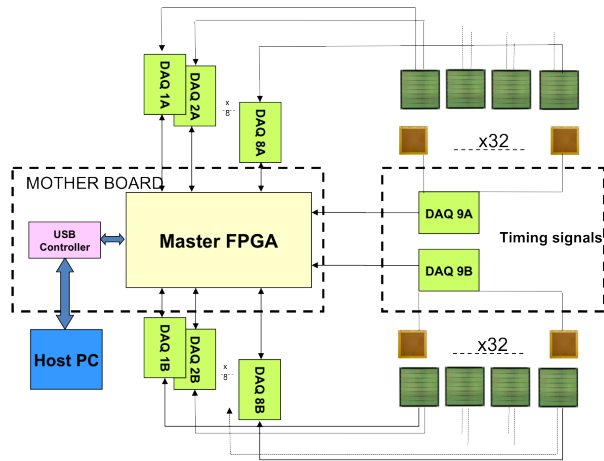

Fig. 2. Acquisition system architecture for the proof of principle prototype.

thanks a fully digital one channel TDC. The communication with the host PC is via USB 2.0 protocol.

B. Acquisition system architecture

The acquisition system, together with the 32 channel version of the BASIC, will allow the construction of a smaller two head proof of principle prototype (see figure 2). Each head will be composed by four 64 channel SiPM matrices to provide the spatial information on one side, and by an array of 6x6 16 mm² SiPM pixels to provide the timing signal on the other side of the crystal. Hence, 8+8 DAQ boards are necessary to read the top layer of the two modules, while 2 spare DAQ boards remain for the read-out of the two modules bottom layers. Although in the future we plan to develop a custom TDC chip to read-out the timing signals, the preliminary use of the BASIC allow us to use the same DAQ board design both for the high and low granularity detection surface by maintaining satisfying timing performances at the same time.

IV. DAQ SYSTEM PERFORMANCES

Currently all the acquisition boards are available and most of the firmware has been written. First tests of one DAQ board mounting an 8 channel version of the BASIC have been carried out in order to prove the excellent performances of our acquisition system in terms of linearity, uniformity and timing capabilities. Measurements have been performed with and without connecting the photodetector to the electronics.

A. System linearity and uniformity

Standard characterization measurements of the front-end chip have been carried out by injecting a variable charge to the 8 BASIC inputs through a capacitor. The calibration curves for the analog stage of the 8 channels (see Figure 3 top) have been demonstrated to be uniform at a 2% level of accuracy. The response of the BASIC for the three different gains that can be set has also been investigated: results are shown in

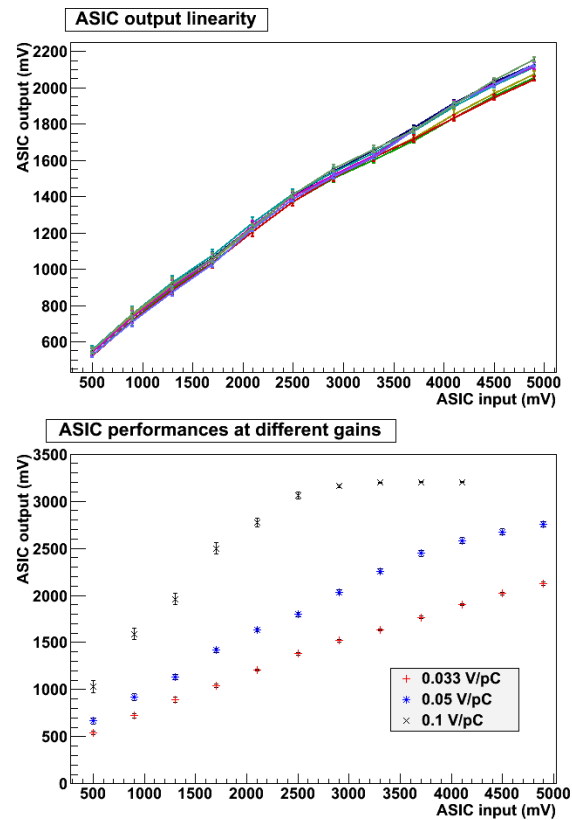

Fig. 3. The calibration curves for the analog stages of the 8 channels of the BASIC chip are shown in the top graph. The response of the BASIC for the three different gains that can be set is reported in the bottom plot.

figure 3 (bottom) for a single channel.

In order to prove the high uniformity of our system, 8 channels of one FBK SiPM matrix on a row have been connected to the BASIC inputs, and then a scanning of the detector has been performed by using a LSO pixel of 1x1 mm² area by 10 mm length. Spectra have been acquired for each scanning position with a 0.5 mm step and counts registered in each SiPM pixel have been plotted as a function of the LSO crystal actual position (see Figure 4). Despite data have not been corrected either for the gain differences among the pixels of the detector or for the gain differences and pedestals of the electronics, we were able to perfectly reconstruct the profile of each SiPM pixel. As it is shown in plot 4 the response is very uniform, and the mean reconstructed pixel width is 1.5 mm, perfectly matching the SiPM matrix pitch.

By using the same set-up measurements, we also reconstructed the position of the LSO crystal with the COG (Center Of Gravity) algorithm and plotted the reconstructed positions versus the actual ones. The correspondence is perfectly linear, as it is shown in figure 5, for all the crystal positions inside the SiPM matrix.

In order to test the whole acquisition chain, a ²²Na spectrum from a LSO crystal of 3x3x10 mm³ size wrapped with teflon and coupled to a 3x3 mm² MPPC by Hamamatsu has been

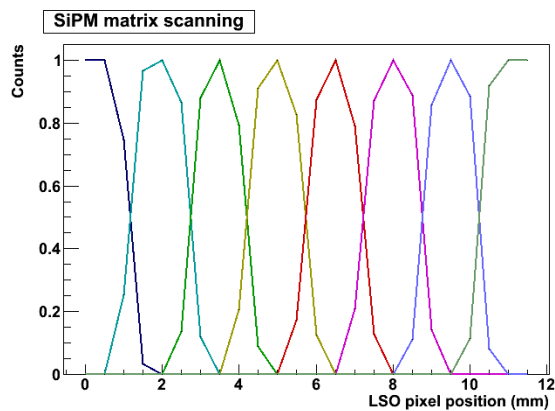

Fig. 4. Reconstructed profiles for 8 channels in a row of the SiPM matrix.

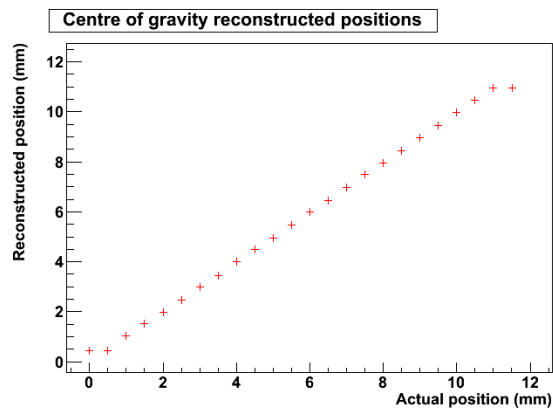

Fig. 5. The COG reconstructed crystal position is plotted versus the actual crystal position. The correspondence is perfectly linear along the whole surface of the matrix.

acquired with the DAQ system developed. The output of the MPPC has been split into two BASIC channels, since the dynamic range of this chip has been optimized for the read-out of LYSO crystals painted black. The spectrum obtained (see Figure 6), with a energy resolution of about 17% at 511 keV demonstrates that the DAQ system preserves the spectroscopy capabilities of the Silicon Photomultiplier.

B. System timing performances

The use of BASIC front-end as a preliminary read-out system for the low granularity detection surface designed for TOF applications, imposes a constrain of few hundreds picoseconds on the chip time jitter when reading a SiPM coupled to scintillator. Hence, extensive measurements have been performed in order to determine its timing performances. BASIC intrinsic time jitter have been evaluated by injecting a fixed charge trough a capacitor so as to measure the chip time jitter without considering the time-walk introduced by signal dynamic. At the oscilloscope we measured the time difference between the FASTOR trigger signal generated by the BASIC and the input signal itself obtaining a typical time jitter of

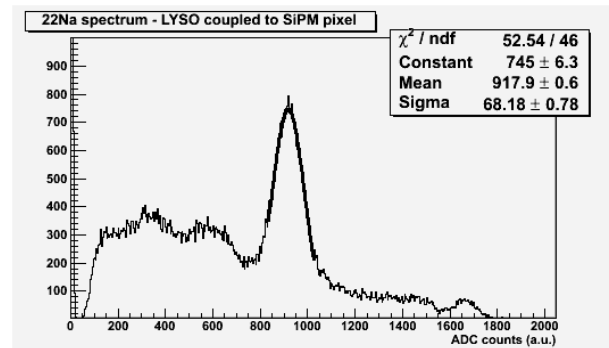

Fig. 6. ^{22}Na spectrum obtained by coupling a $3\times 3\times 10\text{ mm}^3$ LYSO crystal wrapped with teflon to a 3×3^2 area MPPC. The signal of the SiPM has been split into two BASIC inputs.

TABLE I
AN EXAMPLE OF A TABLE

read-out electronics	sigma (ps)
scope-scope	647
scope-BASIC	519
scope	457
BASIC	245

about 50 ps sigma.

Subsequently, the BASIC have been coupled to the detector in order to measure the comprehensive time jitter in the whole scintillator+detector+electronics configuration. Since at the moment only one DAQ board mounting an 8 channels version of the BASIC is available, we could not perform any time coincidence measurements, and hence we needed a system that can provide events intrinsically in time coincidence. Therefore we read-out the same $1\times 1\times 10\text{ mm}^3$ LYSO crystal by coupling two single pixel SiPMs to the two opposite 1 mm^2 faces: in this way, the scintillation light produced by a single event reaches the two detectors at the same time. The BASIC contribute has been extrapolated by measuring the system time jitter at the scope with two different set-up. First, both the SiPM outputs have been sent directly to the scope and their arrival time difference histogrammed (data are referred as *scope-scope*) following the standard double threshold procedure for TOF: a high threshold corresponding to the Compton edge of the LYSO has been used for the coincidence events selection, while a threshold of few photons have been chosen to register the arrival time for each event. The resulting time jitter is 647 ps sigma (see Table I). Then, one of the two SiPMs output is sent to the BASIC input, and then, the corresponding BASIC FASTOR trigger is sent to the scope together with the other SiPM signal in order to obtain the time delay distribution (data are referred as *scope-BASIC*). The resulting time jitter is, in this case, 519 ps sigma (see Table I). This last timing distribution (see Figure 7 black) can be considered as depending by the time jitter of the system LSO+SiPM+BASIC+scope (in table I referred as *BASIC*) and the system LSO+SiPM+scope (in table I referred as *scope*). So, the BASIC contribute can be extrapolated by

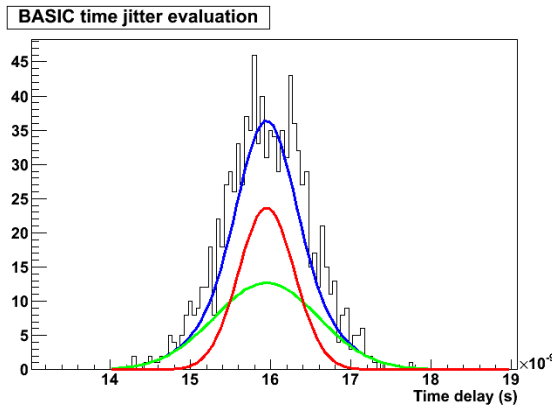

Fig. 7. The time delay distribution obtained with the hybrid BASIC-scope acquisition method is shown in black. Two Gaussians corresponding to the scope-scope contribute (in green) and the BASIC contribute (in red) alone are shown. The Gaussian curve in blue is the sum of the red and the green Gaussians.

simply considering the square sum of the sigma corresponding to the two systems:

$$\sigma_{scope-BASIC}^2 = \sigma_{scope}^2 + \sigma_{BASIC}^2 \quad (1)$$

where $\sigma_{scope-BASIC}$ is the sigma of the so-called *scope-BASIC* distribution, σ_{BASIC} and σ_{scope} are the sigma time jitter with and without the BASIC in the acquisition chain. σ_{scope} has been calculated by dividing by $\sqrt{2}$ the sigma of the *scope-scope* distribution.

In figure 7, the 3 Gaussian curves corresponding to the original data set obtained with the hybrid *scope-BASIC* acquisition method (in blue), the *scope-scope* contribute (in green) and the BASIC contribute (in red) are shown. Results are also listed in table I. For the BASIC chip reading a LSO crystal coupled to a single SiPM in the configuration previously described, the estimated time jitter corresponds to a 245 ps sigma. This result should be considered preliminary since several factors can still be improved: by using two distinct and larger (4x4 mm² size instead of 1x1 mm² size) photodetectors, both of them read-out with BASIC chips in time coincidence we are confident that is possible to reduce the time jitter by several tens of picoseconds. Although this is not the ultimate limit that we plan to achieve for the 4DPET module, this preliminary result can already be considered suitable for time of flight applications, since it represents the standard for clinical TOF-scanners in the market.

V. CONCLUSION

A 4DPET module with TOF and DOI capabilities based on Silicon Photomultipliers is under development at University of Pisa and INFN Pisa. The final system with a detection surface of 4.8 by 4.8 cm² will be the successor of the standard PET block detector. Currently, a reduced size prototype (2.4 by 2.4 cm²) is being constructed. The use of SiPM matrices has required the development of a custom multichannel ASIC front-end capable to respect their high dynamic range and their excellent timing performances. All together a modular

and flexible acquisition system has been designed in order to read out two 4DPET modules in time coincidence.

First characterization measurements of the DAQ system with and without the detector connected have demonstrated its excellent performances in terms of uniformity, linearity and timing response. Its promising spatial resolution capabilities have been proved by reading a SiPM matrix coupled to a single 1 mm² LSO crystal placed at different positions. It has also been shown that our system does not degrade intrinsic SiPM energy resolution. Moreover, preliminary time jitter measurements that can be improved, confirm that the use of the BASIC for the read-out of the timing signals is suitable for time of flight applications, since this chip already assures a performance comparable to that of clinical scanners.

The set-up of the whole system is now straightforward, and it will allow, very soon, the read-out of two whole SiPM matrices in time coincidence.

REFERENCES

- [1] G. Llosa et al., *Energy and Timing Resolution Studies With Silicon Photomultipliers (SiPMs) and 4-Pixel SiPM Matrices for PET* IEEE TNS Vol. 56 no. 3 (2009) 543-548
- [2] G. Llosa et al., *Energy, Timing and Position Resolution Studies With 16-Pixel Silicon Photomultiplier Matrices for Small Animal PET* IEEE TNS Vol. 56 no. 5 (2009) 2586-2593
- [3] F. Corsi et al., N15-49, *Preliminary Results from a Current Mode CMOS Front-End Circuit for Silicon Photomultiplier Detectors* Conference Record of the 2007 IEEE NSS-MIC
- [4] G. Sportelli et al., M09-332, *A flexible acquisition system for modular dual head Positron Emission Mammography* Conference Record of the 2009 IEEE NSS-MIC
- [5] C. Piemonte et al., *Characterization of the first prototypes of Silicon Photomultiplier fabricated at ITC-irst* IEEE TNS Vol. 54 no. 1 (2007) 236 - 244
- [6] G. Collazuol et al., *Single photon timing resolution and detection efficiency of the IRST silicon photo-multipliers* NIMA, Vol. 581 (2007) 461-464
- [7] M. G. Bisogni et al., *Characterization of Ca co-doped LSO:Ce scintillators coupled to SiPM for PET applications* NIMA, doi:10.1016/j.nima.2010.07.016, in press.
- [8] G. Llosa et al., *Monolithic 64-channel SiPM matrices for Small Animal PET* M05-91, Conference Record of the 2009 IEEE NSS-MIC
- [9] F. Corsi et al., N19-2, *BASIC:an 8-channel Front-end ASIC for Silicon Photomultiplier Detectors* Conference Record of the 2009 IEEE NSS-MIC